

HCS-3600 / 3602 / 3604

Laboratory Grade & High RFI Immunity Switching Mode Power Supply with Rotary Encoder Control

User Manual

1. INTRODUCTION

This family of efficient, upgraded SMPS with small form factor, auto cross over CV CC, 3 VI presets, remote control offers unique solution for various loading conditions and applications.

The dual action (coarse/fine tune) rotary encoder tuning with MCU makes setting the voltage and current levels ever so smooth, precise and fast. Setting, changing, and checking the current limit level can be done easily without sparking the output poles.

The remote control functionality allows the output power on/off, voltage & current be adjusted without touching the front panel of the power supply.

It is suitable for a wide range of applications such as laboratory, telecommunication, production testing, field test of voltage critical distant load, powering of dc network and etc...

The 3 user defined presets facilitate quick access to frequently used VI settings.

2. WARNING

- Do not use this power supply near water.
- Do not operate or touch this power supply with wet hands.
- Do not open the casing of the power supply when it is connected to ac mains.
- Refer all servicing to qualified service personnel only.
- Before replacing the AC fuse at AC socket, find out and clear up the cause first.
- Replace the AC fuse with the same type and rating as the original fuse.
- The max. output voltage of Model HCS-3604 is over 60VDC, avoid touch the metal contact part of the output terminals.

3. CAUTION

- Use a grounded 3 pin AC source.
- This unit is for indoor use only.
- Do not operate or place this unit in a humid, dusty, in direct sunlight location or near any heat source.
- Before plugging into local AC mains, check with the rating label at the back of the unit.
- Do not block any ventilation openings of the unit.
- This unit must be used within the specified rating, regular excessive continuous loading may cause damage to the power supply.
- Never short the Remote Sensing Terminal.
- The gauge size of input power cable must be at least 0.75mm² and the total length of power cable must not exceed 3m.

4. OPERATION ENVIRONMENTAL CONDITION

- 10-80% R.H.
- Altitude up to 2000m
- Installation category: CAT 2
- Pollution degree: 2
- Mains supply voltage fluctuation up to ±10% of the normal voltage

5. CONTROLS AND INDICATORS

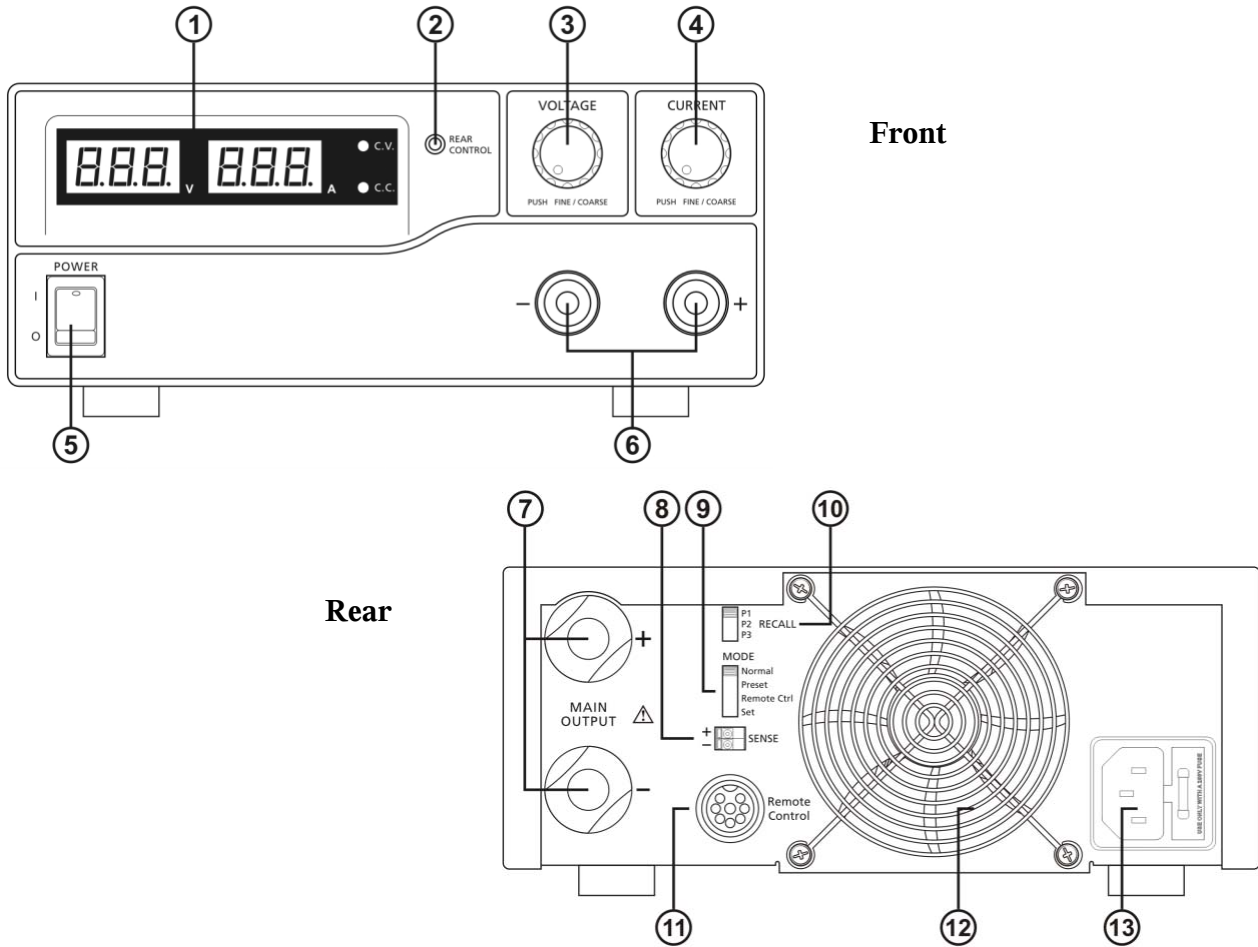

- (1) LED panel meter display with CC/CV Indicator
- (2) Rear Control Indicator (**lights up when using Preset/ Remote Control/ Set mode**)
- (3) Output Voltage Control Knob (**control both the main and auxiliary output voltage**)
- (4) Output Current Control Knob (**control both the main and auxiliary output current limit**)
- (5) Power ON/OFF Switch
- (6) Aux. output terminal (max 5A)
Note: HCS-3600: The total rated current (Aux.+Main) is 60A
HCS-3602: The total rated current (Aux.+Main) is 30A
HCS-3604: The total rated current (Aux.+Main) is 15A
- (7) Output Terminal (**Rated 60A for HCS-3600/ Rated 30A for HCS-3602/ Rated 15A for HCS-3604**)
- (8) Remote Sensing Terminal (**for model HCS-3600 only**)
(Warning!: Shorting the remote sensing terminal or Connect sensing terminal in reverse polarity will damage the power supply)
- (9) Mode Selection Switch (**Normal, Preset, Remote Control, Set Modes**)
- (10) Recall Selection Switch
- (11) Remote Control Terminal
- (12) Cooling Fan Air Intake Grille
- (13) AC Input Plug

6. CONTROL MODE SELECTION

There are 4 modes, Normal, Preset, Set and Remote Control mode for the power supply.

Slide the Mode Selection Switch (9) to your desired Mode.

The power supply is factory preset to Normal Mode with maximum current level CC.

6.1 Normal Mode

This is the factory preset mode and the power supply output V, I are controlled by the dual action volume knobs.

Push the knobs to toggle the coarse and fine tuning, notice the subtle changes in brightness of related LED. .
Adjust the knobs to your desired values by trying coarse and fine tuning .

To check the preset current level , just turn the Current Knob lightly in any direction .

The display will resume its normal brightness after few seconds to double confirm your adjustment.

6.2 Preset Mode

a. In this mode , the Rear Control Light is on to indicate panel V & I controls are de-activated.

b. There are 3 preset output P1/ P2/ P3 at the Recall Selection Switch (10)

c. The preset values are factory set as following table.

d. End user can set his own output rating, please refer to paragraph 6.3

Recall No.	Output Voltage	Output Current
P1	5V	Maximum
P2	13.8V	Maximum
P3	HCS-3600: 15V HCS-3602: 25V HCS-3604: 55V	Maximum

6.3 Set Mode – First enter into the Set Mode by pushing Switch (9) to Set Mode slot.

The power supply is then ready to be preset.

6.3.1 To define the preset output P1/ P2/ P3.

- Select the Recall Switch (10) to the position P1, P2 or P3 which you want to set
- Adjust the front panel voltage control knob to set your desired voltage value
- Adjust the front panel current control knob to set your desired current limit value
- Repeat the procedure for remaining recalls P1, P2, P3 if desired.
- Move Mode Switch (9) from Set to Preset position to confirm your settings.

Remarks:

All the set values in the presets will be kept even after the power supply has been tuned off.

Always check output voltage of Presets before connect to Load

To check the preset values, move Mode Switch (9) to Preset position

Move the Recall Switch (10) to P1, P2 or P3.

The V and I settings of corresponding RECALL P1 ,P2 ,P3 will be show on the panel meters .

6.3.2 To reset the unit back to factory setting

- Turn OFF the power supply
- Push and hold both front panel voltage and current control knobs at the same time
- Turn ON the power supply again
- Release front panel voltage and current control knobs

6.4 Remote Control Mode

To control the output voltage and current by remote control connector (11)

Please refer to paragraph 9

7. Using the power supply









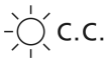
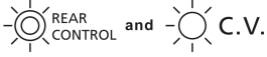

7.1 This series has 3 models. Make sure you have used the correct one. They have different output voltage range and current as following:

Model Number	Output Voltage Range	Total Rated Current
HCS-3600	1 ~ 16V	0 ~ 60A
HCS-3602	1 ~ 32V	0 ~ 30A
HCS-3604	1 ~ 60V	0 ~ 15A

7.2 Check the rating label of the power supply and make sure it complies with your AC mains voltage. Connect the power supply to the AC Mains using the provided power cord.

Make sure the Mode Switch (9) is at Normal Position .

Below table to show the self test sequence

Self test display and Sequence	Test contents
	To show software version
	Segment check
	C.V. Indicator check
	C.C. Indicator check
	Rear control indicator check
	Return to C.V.
	Start to check
	Over voltage protection check
	Over load protection check
	Over temperture protection check
	Fan check
	Output off (remote control mode)

- 7.3** The power supply will perform a series of self checks when it is switched on. The LED and other indicators on the front panel will be on by turn. When the cooling fan is being checked, a high speed wind noise can be heard. After the self checks, the CV, V and A LED indicators are lit up displaying voltage and 0.0 current. To find out about the set CC current level, just turn the current control knob one click in either direction. The current display returns to 0.0 after a few seconds.
- 7.4 Using the control knobs**
The rotary encoder control knobs have fine and coarse tuning with clicking movement. Push the knobs to toggle between coarse and fine tuning, notice the subtle changes in brightness of related LED. . Adjust the knobs to your desired values by trying coarse and fine tuning. The display will resume its normal brightness after few seconds to confirm your adjustment.
- 7.5** Connect the equipment to the power supply. Red (+) is connected to the positive polarity input of the equipment and Black (-) is connected to the negative polarity input of the equipment.
- 7.6** Switch on the power supply first and the panel meter & green CV Indicator should light up again.
- 7.7** Switch on the equipment and the panel meter & green CV Indicator should still remain in green.
- 7.8** You can now operate the equipment.
When an operation is finished, switch off the equipment first and then switch off the power supply.

8. REMOTE SENSING (ONLY HCS-3600 HAS THIS FUNCTION)

Take note of the warnings , wrong disconnection sequence will damage the Power Supply

Warning : Never short the Remote Sensing Terminal
Always disconnect Remote Sensing Terminal first .

Connection:

1. First complete the power connections between power supply and equipment.
2. Check and make sure the power connections are secure.
3. Then make connections between Remote Sensing and equipment.

Warning!: **Never short the Remote Sensing Terminal**
Never connect the Remote Sensing Terminal in reverse polarity

Fig.3 showing connections between Remote Sensing, Power output and Equipment.

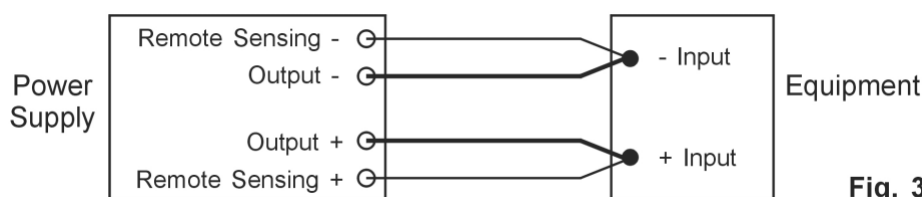

Fig. 3

The remote sensing wire should be AT LEAST 22AWG wire size.

Dis-connection: Wrong disconnect sequence will damage power supply

1. First disconnect the remote sensing connections.
2. Then disconnect the power connections between the power supply and equipment.

9. REMOTE CONTROL MODE

There are two methods for remote control of current and voltage adjustment.

Both methods require current remote control part to be set up in order for remote control mode to be functional, otherwise unit will be in CC mode all the time.

9.1 Method A Using two external variable DC voltage sources

Remote Socket Pin Assignment for external variable voltage source		
PIN	FUNCTIONS	REMARKS
1	Internal DC +5V	Less then 50mA
2	Voltage Adjust	0 - 5V
3	Current Adjust	0 - 5V
4	Ground	
5	Output OFF	Short to Ground
6	N.A.	
7	N.A.	
8	N.A.	

Check the output voltage range of the power supply by varying the external voltage source.

Short circuit the main output with **8AWG** wire to check the display for CC setting varying the external voltage source.

9.2 Method B Using two 0 – 5K Ohm variable resistors

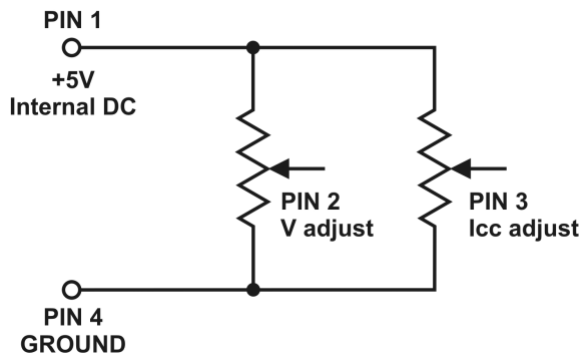

Remark: variable resistors 5Kohm.

Remote Socket Pin Assignment for variable resistor		
PIN	FUNCTIONS	REMARKS
1	Internal DC +5V	Resistor end
2	Voltage Adjust	Variable part of resistor
3	Current Adjust	Variable part of resistor
4	Ground	Another resistor end
5	Output OFF	Short to Ground
6	N.A.	
7	N.A.	
8	N.A.	

Check the output voltage range of the power supply by adjusting the 5Kohm variable resistor.

Short circuit the main output with **8AWG** wire to check the display for CC setting by adjusting the variable resistor.

9.3 Remote Output ON/OFF Control

This remote output on/off control can be activated in any of the modes Normal, Preset, Remote and Set mode.

- A. By default, Pin 5 is open and output is on.
- B. Shorting Pin 5 to Pin 4 (ground) and output is off.
- C. When output is off, the C.V. & C.C. LED will flash. The current output voltage and current setting will show on the panel meter.
- D. You also can adjust the output by voltage & current control knob to your desired value when output is off.

Remark: using the 8pin remote plug provided and connect with 22AWG wires.

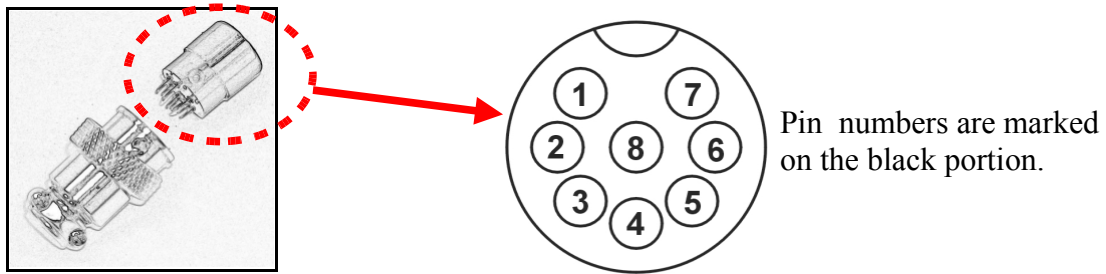

10. FAULTS AND TROUBLE SHOOTING

10.1 OUP: Over Voltage Protection

This unit has a built-in tracking over voltage protection feature. In the event of output voltage becoming greater than the set value (see specified range from specifications table), protection will be triggered and the output power will be cut off and OUP warning appears as below.



To reset the warning, switch off the unit and remove all loading.
Switch the unit back on again and it should resume normal operation.
If this problem persists, please contact and consult with your agent.

10.2 OTP: Over Temperature Protection

There is a thermo sensor inside the unit to monitor and to prevent the unit to gets too hot inside. At OTP, there is no output and the following warning will appear on the LED display.
When you get this warning , switch off the unit and remove all loading.



Check your load and output setting. Allow the unit to cool down for at least 30 minutes.
Check if any of the ventilation is blocked , check enough clearance around power supply.
Listen carefully for the short wind noise from the cooling fan when you turn on the unit again.
If you cannot hear this routine self test wind noise on switch on , the fan is fault and do not use the power supply, contact your agent ..

10.3 OLP: Over Load Protection

Normally the overload protection is sustained by the CC constant current mode.
When the CC mode fails and goes undetected , it may cause serious damage to your test piece or load .
The OLP is to minimize the extent of damage to your loads as power supplies do fail some day.
Switch off your power supply as soon as you see this warning as shown below.



To reset this warning, switch off the unit and remove all loading.
Switch the unit back on again and double check with caution ..
If this problem cannot be fixed, please contact and consult with your agent.

SPECIFICATIONS

Models	HCS-3600	HCS-3602	HCS-3604
Output			
Variable Output Voltage	1 - 16VDC	1 - 32VDC	1 - 60VDC
Variable Output Current	0 - 60A	0 - 30A	0 - 15A
Voltage Regulation			
Load (0-100% Load)	50mV		
Line (90-130VAC Variation)	20mV		
Current Regulation			
Load (10-90% Rated Voltage)	200mA	150mA	100mA
Line (90-130VAC Variation)	50mA		
Ripple & Noise			
Ripple & Noise (r.m.s.) Voltage	5mV		
Ripple & Noise (peak-peak) Voltage	50mV	50mV	100mV
Current Ripple & Noise (r.m.s.)	100mA	50mA	15mA
Meter Type & Accuracy			
Voltage Meter	3 Digit LED Display $\pm 0.2\%$ +3 counts		
Current Meter	3 Digit LED Display $\pm 0.2\%$ +3 counts		
Other			
Input Voltage	100 – 120VAC 50/60Hz~ (or on request)		
Full Load Input Current	9.5A	9A	9A
Efficiency	85%	86%	88%
Switching Frequency	65 – 85Khz~	75 – 95Khz~	65 – 85Khz~
Tracking Over Voltage Protections	O/P 1-5V: set voltage +2V O/P 5-15V: set voltage +3V	O/P 1-5V: set voltage +2V O/P 5-20V: set voltage +3V O/P 20-30V: set voltage +4V	O/P 1-5V: set voltage +2V O/P 5-20V: set voltage +3V O/P 20-60V: set voltage +4V
Transient Response Time (50-100% Load)	1.5ms		
Power Factor Control	Power factor correction >0.95 at optimal load		
Cooling Method	Thermostatic Control Fan from Zero to full speed		
Protections	Overload, Short Circuit by Constant Current, Output Tracking Over Voltage, Over Temperature		
Special Features	3 User defined VI preset, Remote control V, I and output on-off, Remote Sensing (for HCS-3600 only)		
Approvals	CE EMC: EN 55011, 55022 LVD: EN 60950, 61010		
Dimensions (WxHxD)	200 x 90 x 275 mm 7.9 x 3.5 x 10.8 inch		
Weight	3.2 kg 7 lbs		

CASWELL

Rev.0 11/2010
7673-3600-1270